

Colección | 2016/2017

Collection



Su ambiente,
su estilo.

*Your surroundings,
your style.*

Estilo, durabilidad y visión ambiental

Las puertas y componentes Famossul unen design contemporáneo y alta calidad para dar personalidad a los ambientes. Son productos fabricados con maderas reforestadas, patrones constructivos diferenciados, delicadas terminaciones y mayor funcionalidad, resistencia y belleza. Su proyecto merece puertas Famossul.

*Style, durability
and environmental vision*

Famossul's Doors and Components join contemporary designs and high quality to add personality to the surroundings. The products are made with renewable wood, detailed construction standards and fine finishes. They are much more functional, resistant and beautiful. Your project deserves Famossul.



Experiencia en el área

Market Experience

Con más de 40 años de actividad en el mercado de la madera y comprobada trayectoria internacional, Famossul enfoca toda su experiencia al segmento de la construcción civil. Cuenta con una amplia y moderna estructura industrial, con más de 32 mil metros cuadrados de área construida en tres unidades fabriles, posee tecnología de punta e innovadores procesos de producción. Profesionales altamente calificados garantizan eficiencia industrial en permanente evolución. Famossul es referente de calidad, competitividad, cumplimiento riguroso de los plazos de entrega y acuerdos comerciales.

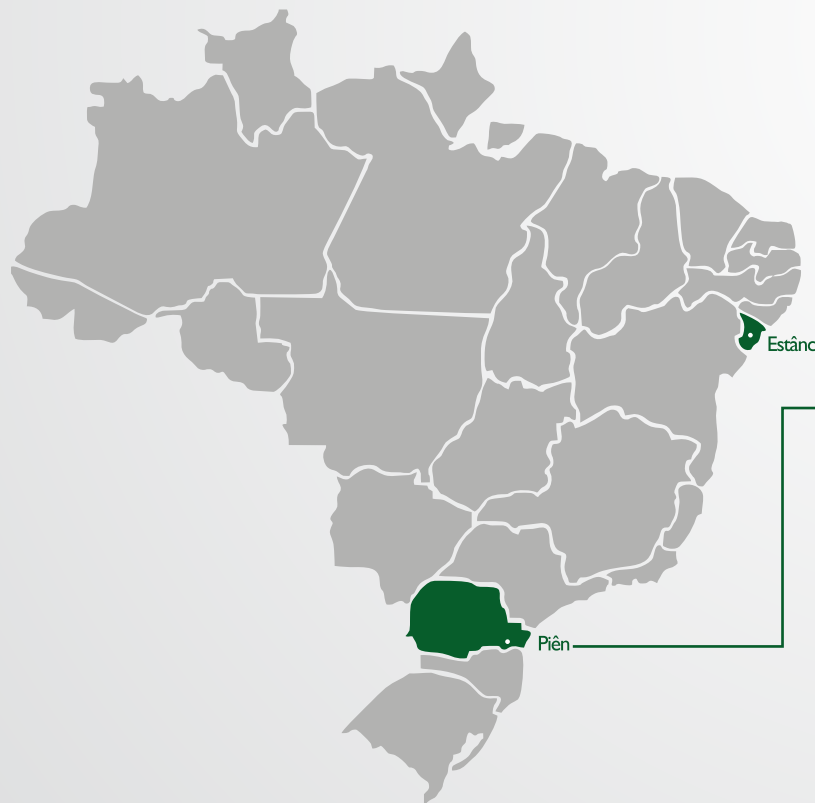



With more than 40 years of operation in the lumber area and proven international experience, Famossul directs all of its experience to the civil construction area. In a large and modern industrial structure with more than 32,000 m² of building area distributed in 3 plants, end equipment and updated processes are applied. Highly qualified professionals guarantee industrial efficiency and permanent evolution. Famossul has become known for quality, competitiveness, and straight compliance with deliveries and commercial agreements.



Calidad certificada

Certified Quality

Para Famossul, la calidad es una cuestión de honor. Las certificaciones obtenidas avalan su preocupación con los estándares de calidad de los productos y el medio ambiente. La empresa posee certificaciones de la ABTN – Asociación Brasileira de Normas Técnicas - conquistada luego de rigurosos controles técnicos de fabricación, también de la FSC®, que comprueba la utilización de madera proveniente de manejo forestal pautado por la gestión ecológicamente correcta, socialmente justa, viable económicamente y comprometida con las leyes vigentes.

For Famossul quality is a matter of honour .The certifications are a proof of the concern with the quality of the products and the environment.The company has a conformity certificate for wooden door sheets from ABNT –The Brazilian Association of Technical Norms, achieved through strict technical controls. Famossul has the FSC certification, which proves that the wood used is from a managed forest, in line with adequate ecological management, socially fair, economically viable and committed to the current laws.



A marca de gestão florestal responsável
Procure produtos certificados FSC®





A lo largo de su trayectoria, para Famossul, la preservación ambiental ha sido de un valor inestimable. La empresa Vida Forestal, integrante del grupo, conserva 3.200 hectáreas reforestadas con árboles de la especie pinus en los estados de Paraná y Santa Catarina. Avanzadas técnicas de manejo forestal son utilizadas, garantizando la provisión de madera reforestada de alta calidad y resistencia, aliadas a las extensas áreas de preservación. En la producción, las prácticas ecológicas son respetadas en todos los procesos. En Famossul, la conciencia ambiental se traduce en acciones diarias de respeto a las futuras generaciones.

For Famossul the environment preservation is invaluable, shared throughout its history. An integrant of the group, Vida Florestal maintains 3200 hectares of land with plantations of pine trees in the states of Parana and Santa Catarina. Advanced forest management techniques are used, guaranteeing the supply of reforested lumber of high quality and resistance, along with extensive areas of permanent preservation. During manufacturing, ecological practices are respected in all processes. Environmental consciousness, at Famossul, is transformed into daily actions in respect to future generations.







Colección
Collection

Vanguard





Línea Decor

Decor Line

Lanzamiento

Launching

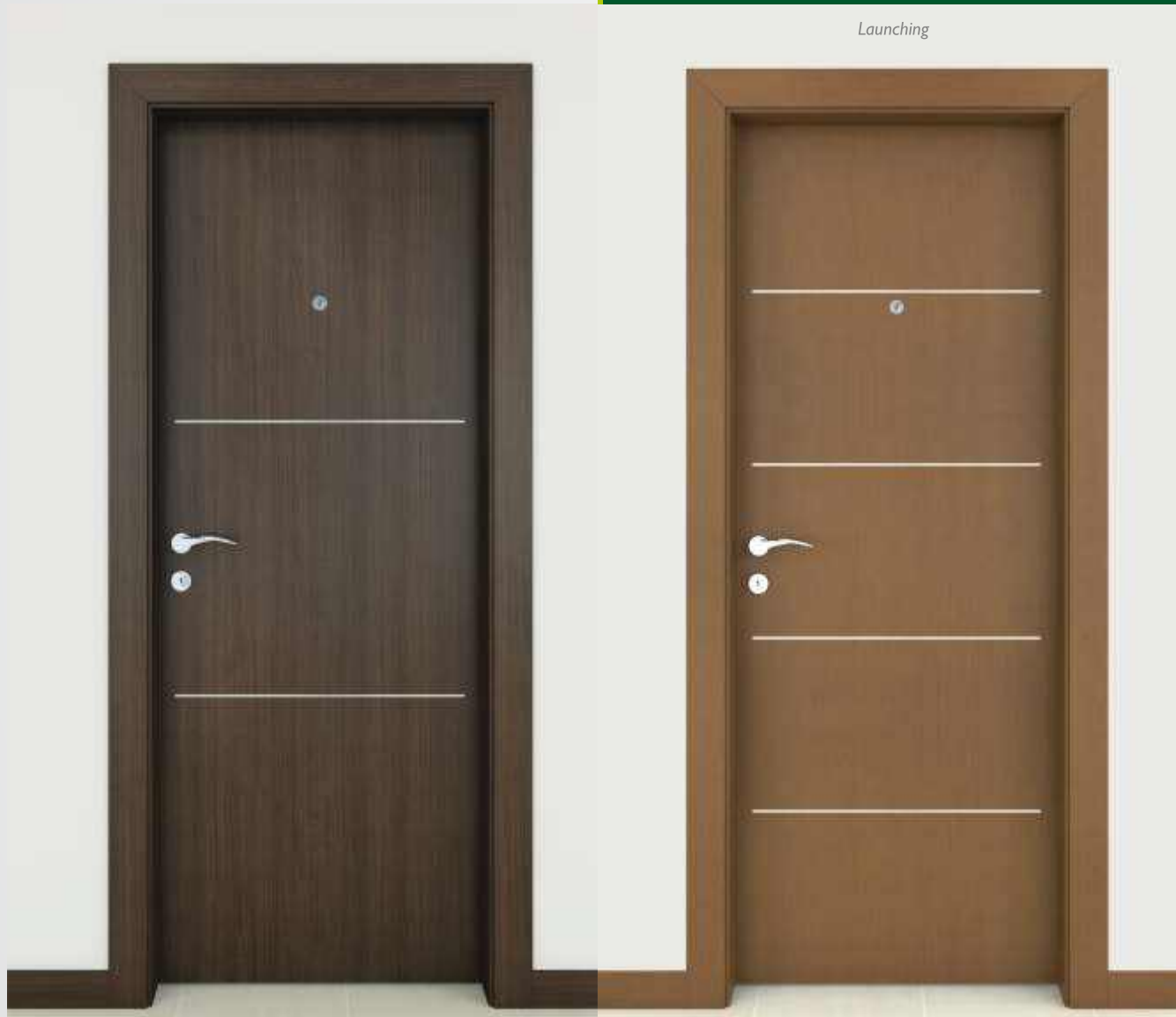

Carvalho Murano

2 apliques largos horizontales

2 long horizontal appliqués

Capuccino Marchê

4 apliques largos

4 long appliqués

Design contemporáneo, terminaciones nobles y tendencias de decoración para dar sofisticación a su ambiente.

Contemporary design, fine finishes and decorative trends to take sophistication to your surroundings.

Terminación: Revestimiento melamínico.
Aplicación de perfil de aluminio opcional.

Finishing: Recovered with melamine resin. Option to apply aluminium appliqués.



Línea Decor

Decor Range



Marfim Adriático
1 applique largo horizontal

1 long horizontal appliqué

Carvalho Murano
4 apliques superiores

4 upper appliqués

Carvalho Pescara
2 apliques largos verticales

2 long vertical appliqués

Carvalho Pescara
4 apliques inferiores

4 lower appliqués

Línea Lisa

Flush Range

Lanzamiento

Launching



Carvalho Pescara

Marfim Adriático

Carvalho Murano

Capuccino Marchê



Hoja de la puerta lisa de madera para uso en interiores
Hoja de la puerta para uso en interiores
Hoja de la puerta de entrada

Flush Wooden Door for indoor use
Indoor door – PIM
Entrance door – PEM

Colección

Collection

Premium





Línea Frisada

Grooved Range



Branco Carrara
4 ranuras horizontales

4 horizontal grooves



Branco Carrara
Belíssima

Belissima

Belleza, calidad y versatilidad,
combinadas con su buen gusto,
valorizan el ambiente.

*Beauty, quality and versatility, which combine with your good
taste and bring value to your surrounding.*

Terminaciones: Esmalte blanco e impresión UV
en la hoja de la puerta y revestimiento
melamínico en los marcos y contramarcos.

*Finishing: Painted (white) and UV Printed on the door sheet and
recovered with melamine resin on the door jambs and door frames.*

Línea Frisada

Grooved Range



Curupixá Ravenna
Belíssima

Belissima

Freijó Nogara
4 ranuras

4 Grooves

Tauari Tolentino
5 ranuras

5 Grooves

Branco Belluno
Belíssima

6 Grooves

**Terminación
texturizada**

Textured Finishing



Línea Lisa

Flush Range

Lanzamiento

Launching



Ipê San Remo

Tauari Tolentino

Freijó Nogara

Branco Carrara

Branco Belluno

Texturizado

Textured



Hoja de la puerta lisa de madera para uso en interiores
Hoja de la puerta para uso en interiores
Hoja de la puerta de entrada

Flush Wooden Door for indoor use
Indoor door – PIM
Entrance door – PEM



Terminación: fondo primer

Hoja de la puerta ranurada y lisa

*Finishing: white primer base. Grooved and
Flush doors*



Informaciones técnicas

Technical Information



Diferenciales

Differentials

- Madera reforestada de alta calidad y resistencia, secada en secadores propios
- Cierre suave y eficiente
- Encajes precisos
- Goma de aislamiento (opcional)
- Utilización de adhesivos resistentes D4 y P.U.R.
- Tapacantos de PVC pegados con cola P.U.R.
- Conjunto de marcos y contramarcos regulables
- Revestimientos con capas de HDF de 3mm o 6mm
- Aplicación de revestimiento melamínico de mayor espesor
- Detalles decorativos
- Terminación de alta gama
- Productos certificados por las normas ABNT

- Renewable lumber of high quality and resistance, dried in our own kiln driers
- Smooth and efficient closing
- Precise fit of the door jamb components
- Rubber seal (optional)
- Resistant adhesives D4 and P.U.R. are used
- PVC Edge tape applied with P.U.R. glue
- Adjustable sets of door jamb and door frame
- 3mm or 6mm HDF cover caps for the doors
- Thicker melamine resin applied
- Decorative details
- High standard finishing
- Products certified through ABNT guidelines



Dimensiones

Dimensions

Alto	Ancho	Espesor
2100	600/620mm	30mm / 35mm* / 41mm
2100	700/720mm	30mm / 35mm* / 41mm
2100	800/820mm	30mm / 35mm* / 41mm
2100	900/920mm	35mm / 41mm
2100	1000/1020mm	35mm / 41mm

Revestimiento con capa de HDF 3mm solamente para espesores de 30mm y 35mm

Revestimiento con capa de HDF 6mm solamente para espesores de 35mm y 41mm

* Productos certificados por las normas ABNT

Height	Width	Thickness
2100	600/620mm	30mm / 35mm* / 41mm
2100	700/720mm	30mm / 35mm* / 41mm
2100	800/820mm	30mm / 35mm* / 41mm
2100	900/920mm	35mm / 41mm
2100	1000/1020mm	35mm / 41mm

Cover caps in 3mm HDF only for doors in 30 and 35mm thick

Cover caps in 6mm HDF only for doors in 35 and 41mm thick

*Products certified by ABNT

Patrones Constructivos

Constructive Standards



Panal

Hive core



Semisólida

Semi solid



Estructurada

Structured

Patrones de colores

Color Standards

Launching

Lanzamiento



Capuccino Marchê
Colecciones Vanguard
y Premium

Collection Vanguard and Premium

Launching

Lanzamiento



Ipê San Remo
Colecciones Vanguard
y Premium

Collection Vanguard and Premium

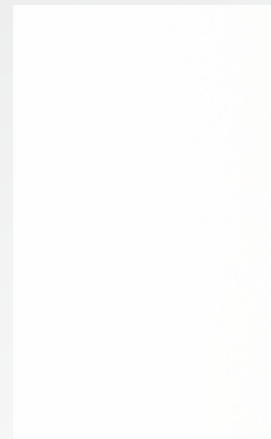

Branco Carrara
Colecciones Vanguard
y Premium

Collection Vanguard and Premium

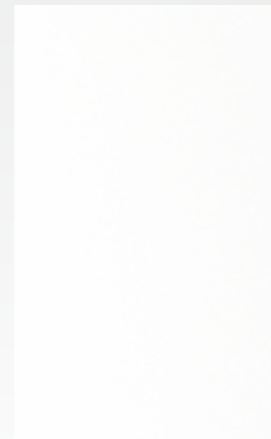

Branco Belluno
Colección Premium

Collection Premium

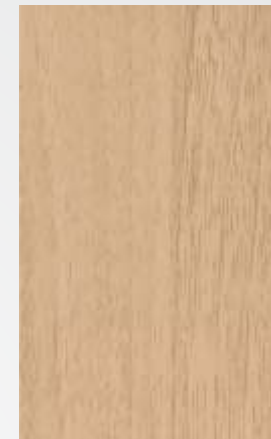

Marfim Adriático
Colección Vanguard

Collection Vanguard



Carvalho Pescara
Colección Vanguard

Collection Vanguard



Carvalho Murano
Colección Vanguard

Collection Vanguard



Tauari Tolentino
Colecciones Vanguard
y Premium

Collection Vanguard and Premium



Curupixá Ravenna
Colecciones Vanguard
y Premium

Collection Vanguard and Premium



Freijó Nogara
Colecciones Vanguard
y Premium

Collection Vanguard and Premium



Wengue Mediterráneo
Colecciones Vanguard
y Premium

Collection Vanguard and Premium

Marcos

Door Jambs

Enmiendas de los Marcos

Finger jointed and Edge glued Doors Jambs

Regulación 1 lado con encaje

- 1 lado con regulación de hasta 10mm
- 1 lado con regulación de hasta 25mm
- 1 lado con regulación de hasta 45mm

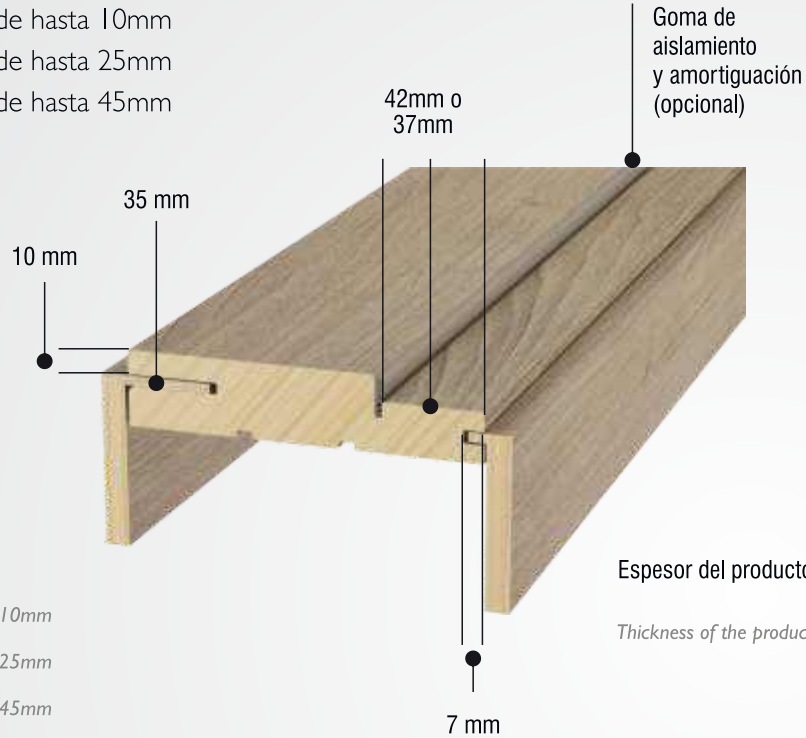

Ajustable 1 side with fit

- 1 side with adjustment of until 10mm
- 1 side with adjustment of until 25mm
- 1 side with adjustment of until 45mm

Finger-Joint

- Con primer blanco o teñido
- Recubierto con revestimiento melamínico (opciones maderada y blanca)
- Con o sin canal para goma de aislamiento/amortiguación

White primed or stained ■

Recovered with melamine resin (white or wooden grains) ■

With or without groove for rubber application ■



Contramarcos regulables

Door Frames with adjustment

- Con primer blanco o teñido
- Recubierto con revestimiento melamínico (opciones maderada y blanca)

White primed or stained ■

Recovered with melamine resin (white or wooden grains) ■





Zócalos

Skirting



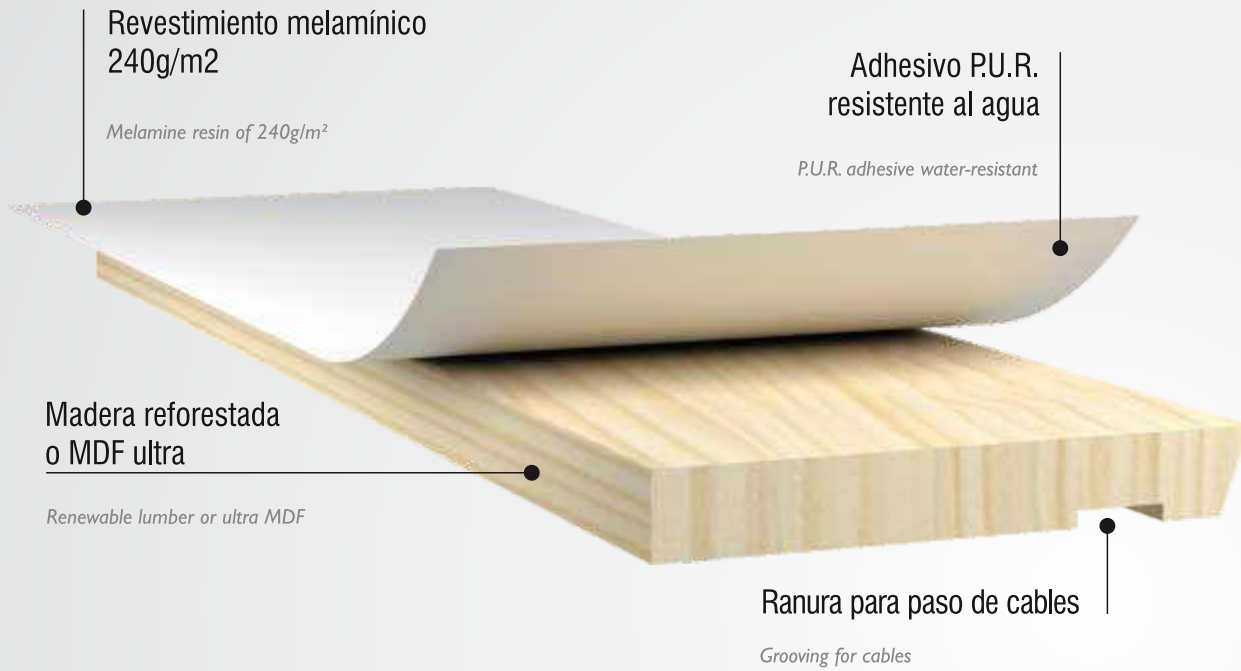

Los zócalos de MDF ultra poseen la certificación FSC®

The ultra MDF skirting are FSC® certified



A marca da gestão florestal responsável!
Procure produtos certificados FSC®

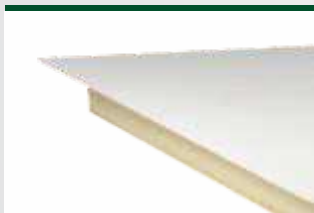

Mayor cubrimiento del revestimiento melamínico para proteger contra la humedad

Thicker melamine resin coverage for moisture protection



Adhesivo P.U.R. resistente al agua

Water resistant P.U.R. adhesive



Zócalo en MDF ultra

Ultra MDF skirting



Canto recto

Straight profile



Terminación con revestimiento melamínico 240g/m²

Finished with melamine resin of 240g/m²



Embalaje para venta al por menor en cajas de 5 unidades de 2,16 metros (10,8 metros lineales)

Retail packaging with 5 pieces of 2,16 meters each (10,8 linear meters)

Zócalo de MDF ultra
Espesor: 15mm

Ultra MDF skirting thickness: 15mm

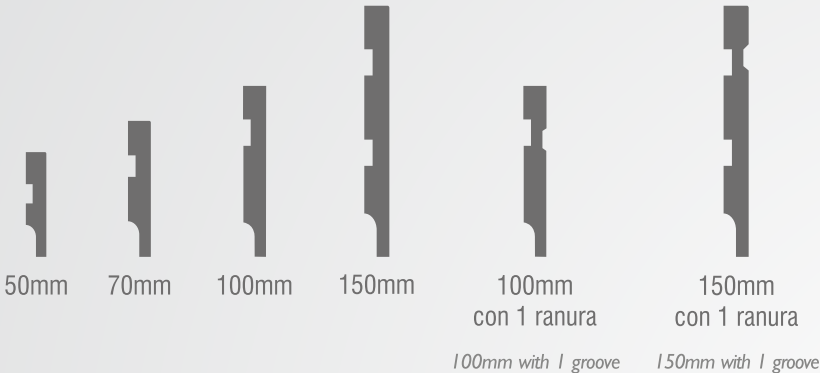

Zócalo de madera
Espesor: 10mm y 14mm

Wooden skirting thickness: 10mm and 14mm

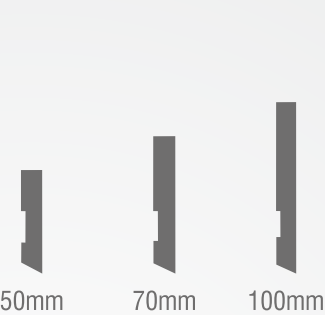

Patrones constructivos

Constructive standards



Zócalo en MDF ultra con alta resistencia a la humedad y termitas

Ultra MDF skirting with high resistance to moisture



Zócalo en madera reforestada

Skirting of renewable lumber



Instalación

Los zócalos pueden ser fijados a la pared con tornillo chato, perno de acero o cola de alta resistencia

Installation: The skirting could be attached to the wall with flat-head screws, steel pins or high resistance glue



Terminación

Los zócalos ya vienen terminados con revestimiento melamínico, blanco, maderado o en PVC blanco, también pueden pintarse. Para evitar manchas, no deben ser encerados o pulidos

Covering: The skirting are finished already with melamine resin, white or wooden grained or in white PVC, but also could be painted. In order to avoid stains, they should not be waxed or polished



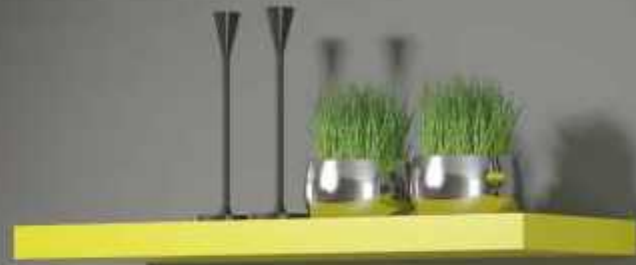

Estantes

Shelves



HOME ART
design



Stante | Elemento

Shelf



Los estantes poseen alto patrón de calidad y son fáciles de instalar. Son bellos, prácticos y organizan ambientes tanto residenciales como corporativos.

*The shelves receive a high standard of quality and are easy to settle.
It is more beauty, practicality and organization to home and corporate surroundings.*

Diferenciales

Differentials

- Fabricado con MDF 6mm
- Tapacantos en PVC
- Terminados con pintura UV
- Producto acabado con pintura antibacteriana
- Soporta de 10kg a 15kg por estante

- *Manufactured with 6mm MDF*
- *PVC edge tape*
- *UV Finishing*
- *Product finished with antibacterial painting*
- *Supports between 10Kg till 15Kg per shelf*

Dimensiones disponibles

Available dimensions

- Longitud: 600mm – 800mm – 1000mm
- Profundidad: 250mm
- Espesor: 41mm

- *Lengths: 600 – 800 – 1000mm*
- *Depth: 250mm*
- *Thickness: 41mm*



Soporte de fijación embutido
Sistema moderno y de fácil instalación

Built-in attaching support

Modern and easy system to install

Patrones de colores

Color Standards

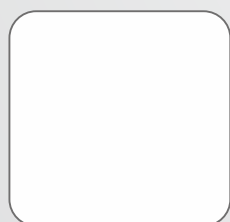

Branco Quartzo



Amarelo Ametista

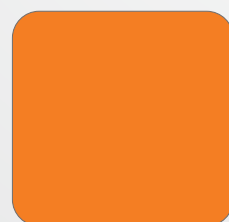

Laranja Ágata



Rosa Topázio

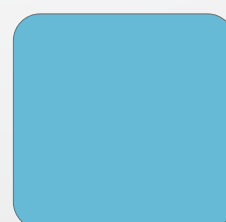

Azul Turquesa

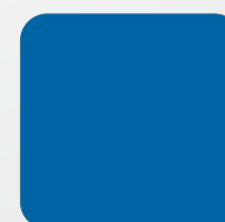

Azul Safira

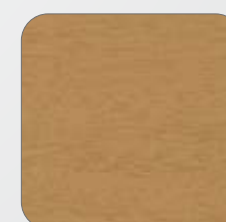

Madeirado Tauari



Madeirado Wengue

Estante | Forma

Shelf



Fáciles de instalar, los estantes ofrecen belleza, practicidad y organizan ambientes tanto residenciales como corporativos.

Easy to install, the shelves offer beauty, practicality and organization to home and corporate surroundings.

Diferenciales

Differentials

- Fabricado con MDF
- Tapacantos de PVC
- Terminación con pintura UV
- Producto acabado con pintura antibacteriana
- Soporte de 5kg a 10kg por estante

- *Manufactured in MDF*
- *PVC edge tape*
- *UV Finishing*
- *Product finished with antibacterial painting*
- *Supports between 5Kg till 10Kg per shelf*

Dimensiones disponibles

Available dimensions

- Longitud: 400mm - 600mm
800mm - 1000mm
- Profundidad: 250mm
- Espesor: 15mm

- *Lenghts: 400 – 600 – 800 – 1000mm*
- *Depth: 250mm*
- *Thickness: 15mm*

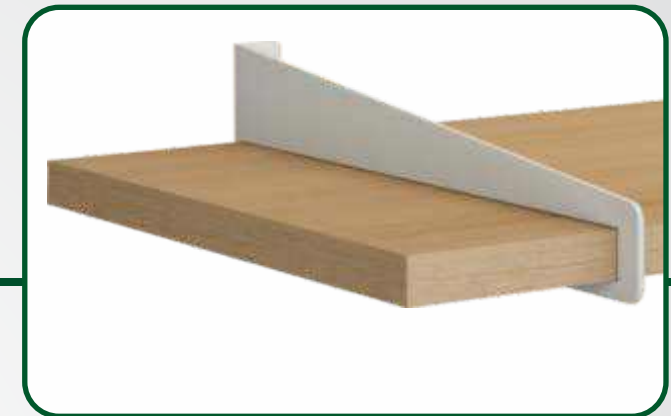

Innovador soporte metálico
Design moderno y facilidad de instalación

Innovative metal support

Modern design and easy to install

Patrones de colores

Color Standards



Branco Quartzo



Amarelo Ametista

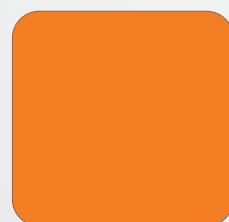

Laranja Ágata



Rosa Topázio

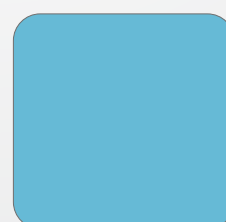

Azul Turquesa

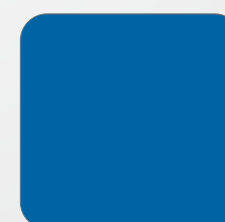

Azul Safira

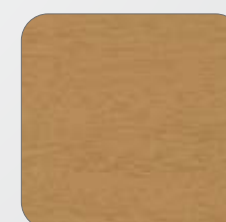

Madeirado Tauari



Madeirado Wengue





Telefone (41) 3632-8300
E-mail contato@famossul.com.br
www.famossul.com.br

Avenida Paraná, 970 – Tricolândia
CEP 83860-971 – Piên – PR – Brasil

Rua A, Quadra 04, Lotes 29 a 34 - Distrito Industrial
CEP 49200-000 - Estância - SE - Brasil



Hoja de la puerta lisa de madera para uso en interiores
Hoja de la puerta para uso en interiores
Hoja de la puerta de entrada

Flush Wooden Door for indoor use
Indoor door – PIM
Entrance door – PEM



A marca da
gestão florestal
responsável
Procure produtos certificados FSC®





www.famosul.com.br